

Please go to www.quoizel.com for product cleaning tips. Go to the **Care + Maintenance** selection.

Tools Required: Flathead screwdriver, Phillips screwdriver, pliers, wire cutters, wire strippers, electrical tape, safety glasses.

Light Source: (12) G9 Xenon Frosted bulbs (Supplied), 40W Maximum.

Estimated Assembly Time: 20-30 minutes

Preparation: Identify and inspect all parts before beginning installation. Check package content list and diagrams below to be sure all parts are present. If any parts are missing or damaged, do not attempt to assemble, install, or operate the fixture. Contact customer service for replacement parts.

⚠ Warnings and Cautions

Turn off electricity at circuit breaker or main fuse box before installation. Consult a licensed electrician if in doubt.

These instructions are provided for your safety. It is very important you read them completely before installing the fixture. We strongly recommend that a licensed, professional electrician perform the installation.

Disconnect fixture from power source before replacing bulbs. Make sure bulbs are given sufficient time to cool before removal.

Do not touch the bulb with bare hands use a cloth or glove.

Package Contents

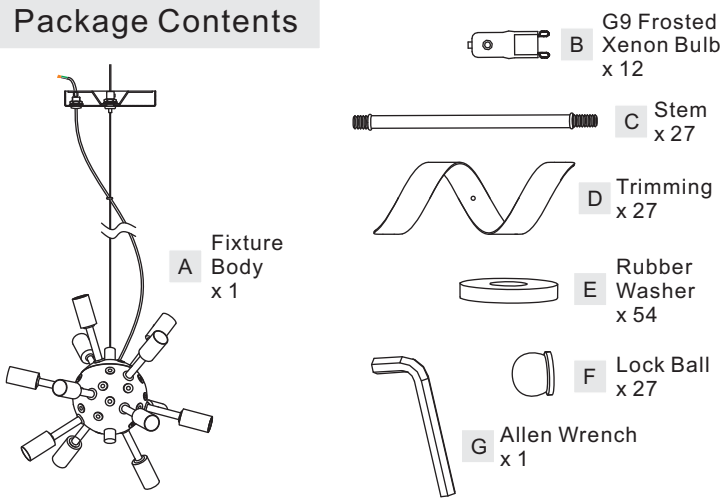

(Step 2 Continued)

height. Release your hand on the pin and move the cable clasp to the crossbar. Tight the set screw on the cable clasp until snug to engage the cable.

B. Adjust the fixture supply wires until it is slightly longer than the cable. Move the wire clasp to the hex nut inside of the ceiling canopy.

STEP 3 – Make Wire Connections

A. Use standard wire connectors (not included) to make all wire connections. Twist connectors until wires are tightly joined together. Wrap each connection with approved electrical tape and carefully stuff all the connected wires into the Outlet Box.

B. If the electrical wire is going to be cut shorter than provided, strip back the clear wire covering the 3 fixture wires as far as you need to. This will expose each fixture wire individually. Strip each end of 3 fixture wires.

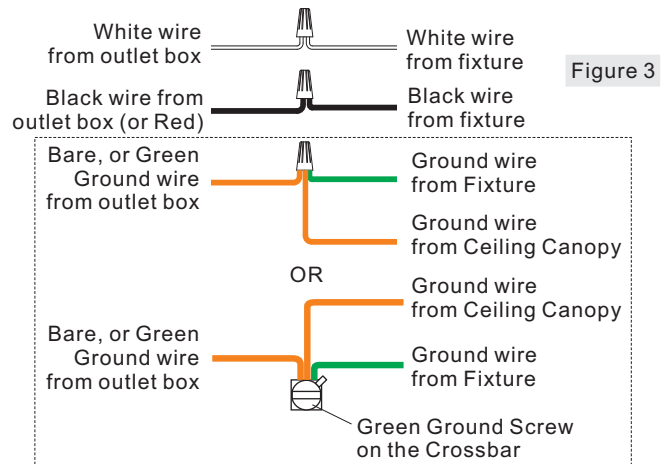

STEP 1 – Install Crossbar Assembly

A. Unlock the lock ring from the bottom center of the ceiling canopy and remove the crossbar assembly from the ceiling canopy.

B. Attach the crossbar assembly to the outlet box and secure with outlet box screws (not supplied). Tighten until snug with screwdrivers.

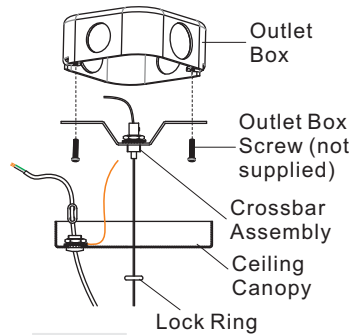

STEP 2 – Adjust the Fixture Body Height

A. By using the Allen Wrench (G), unscrew the set screw on the cable clasp. Push the pin on the bottom center of the crossbar and adjust the cable to your desired hanging

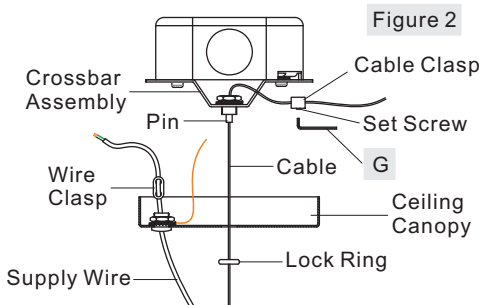

STEP 4 – Install the Fixture Body

A. Position the ceiling canopy onto the crossbar assembly and secure with the lock ring. Hand tighten until snug.

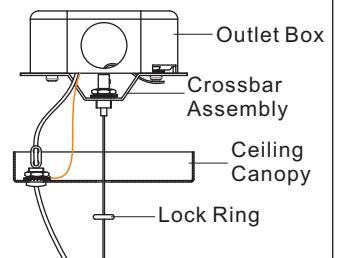

Thank you for purchasing a Quoizel product.
Need assistance with parts or assembly? Call Quoizel customer service at 1-800-645-3184 or visit us on-line at www.quoizel.com

STEP 5 - Install Bulbs

A. Insert bulbs (B) onto sockets and push snugly into place.

IMPORTANT: Do not touch the bulb with bare hands use a cloth or glove.

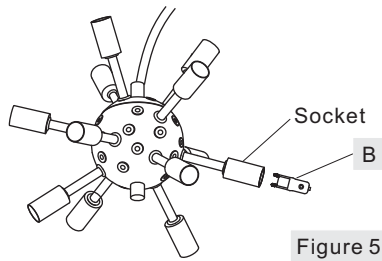

Figure 5

STEP 6 - Install Trimming to Fixture

A. Thread one end of the Stem (C) into the Fixture Body (A), hand tighten until snug.

B. Place the Trimming (D) and Rubber Washers (E) over the other end of Stem (C). Secure by threading Lock Ball (F) onto the Stem (C). Hand tighten until snug.

Your fixture is now assembled and ready to use. Enjoy!

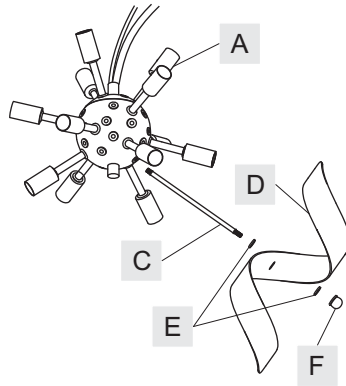

Figure 6

CAUTION FOR BULB REPLACING

- A. When replace bulb, turn off power and allow lamp to cool. For safety purpose, wear gloves and eye protection.
- B. If bulb is scratched or cracked, DO NOT use the lamp to avoid breakage during use or installation.
- C. Use only in fixtures rated for lamps wattage and voltage.
- D. Prevent the bulb from contacting liquid or combustible materials.

RBN2823MN

FINISH: MILLENIA

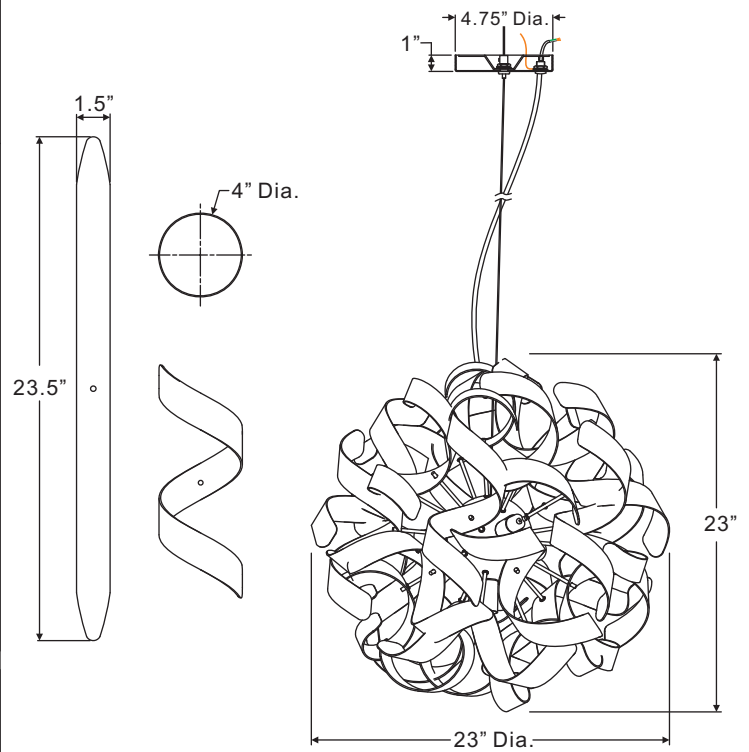

NOTE: ALL DIMENSIONS ARE ROUNDED UP TO THE NEAREST 1/4"

Thank you for purchasing a Quoizel product.
Need assistance with parts or assembly? Call Quoizel customer service at 1-800-645-3184
or visit us on-line at www.quoizel.com