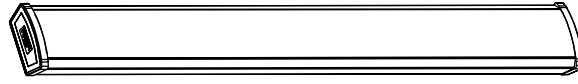


PRODUCT NAME:LED Ceiling Wrap Fixture
 ITEM NUMBER: 57521 57522 47603004 47589004

Please consult a qualified electrician for hanging fixture and wiring!



Before getting started,ensure the package contains the following componets:
 Antes de comenzar,asegurese de que el paquete contenga los siguientes componentes:
 Avant de commencer,assurez-vous qu le paquet contient les composants suivants:

All PARTS CONTENTS


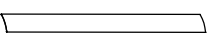


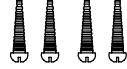
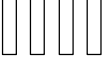
					
A	B	C	D	E	F
Fixture x1	Diffuser (Integrated with fixture in transit) x1	Mounting Screw x2	Wire Connector x3	Tapping Screw x4	Anchor x4

Figure 1

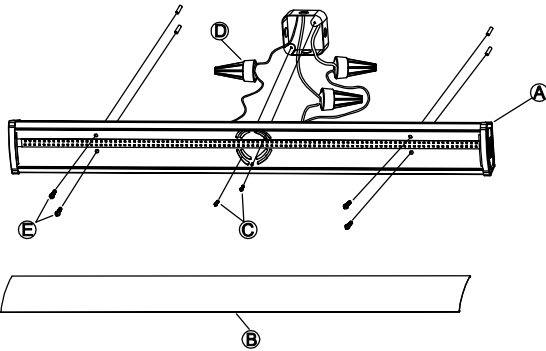
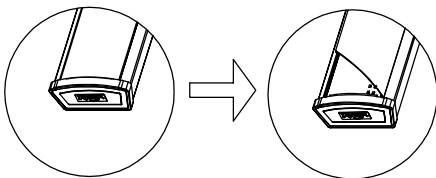


Figure 2



CAUTION: Due to inrush current input,the light series should not exceed 150W of product for a 600W dimmer.
Note:Turn off power at fuse or circuit breaker box!

INSTALLATION INSTRUCTION

- 1,Remove diffuser (B) from housing (A) -near one end of housing,grasp edge of diffuser and carefully squeeze to release diffuser from housing.Continue down length of diffuser to fully disengage.
 - 2,Remove fixture components and parts pack (s) .Check that all parts are included.
Warning: Safely dispose of packaging materials.Assistance may be required to support fixture during installation.
This fixture requires to be surface mounted using a standard ceiling junction box (hardware included) ,depending on your mounting-hole spacing.
 - 3,with the power turned off ,thread two screws (C) into junction box (note:screws shall be the same distance apart as mounting hole in back of housing assembly) ,and further fix the fixture by other 4pcs tapping screws (E) to the intended ceiling.
- Wiring and fixture operation caution:
 Connect fixture to supply wires rated for at least 90 ° C (194 ° F) .
 Consult a qualified electrician to ensure adequate supply wire rating.
- 4,Hold the fixture housing (A) firmly and connect the ground wire from fixture to the ground wire of power supply ,the white wire from fixture to neutral wire of power supply,the black wire from fixture to live wire of power supply,all by 3pcs wire nuts (D) connect together.-see Fig.1.
 - 5,Hold fixture housing (A) in one hand and with the other hand position wires up into junction box.
 - 6,Align mounting holes on back of fixture housing with screws previously installed in junction box.Lift fixture up,rotate clockwise and tighten screws to secure housing assembly against ceiling.
 - 7,To install diffuser (B) -starting at one end of housing,insert diffuser slot onto edge of housing.-see Fig.2. Carefully squeeze diffuser to engage opposite side with housing.Continue this action down length of diffuser until fully installed onto housing.
 - 8,Turn on electricity at fuse or circuit breaker box and verify success of installation.

Light Source: LED Integrated 40W

Made in China/Hecho en China/Fabrique en China

Before Getting Started	Antes de comenzar	Avant de commencer
Read the instructions carefully prior to assembling the product.	Lire attentivement les instructions avant d'assembler le produit.	Lea atentamente las instrucciones antes de ensamblar el producto.
When you open the package with a sharp tool like a cutter knife, be careful not to damage the components inside.	Lorsque vous ouvrez le paquet avec un outil pointu comme un couteau de coupe, veillez à ne pas endommager les composants à l'intérieur.	Cuando abra el paquete con una herramienta afilada como un cuchillo de corte, tenga cuidado de no dañar los componentes dentro.
Carefully remove all packaging materials and retain for future use.	Retire con cuidado todos los materiales de embalaje y consérvelos para usarlos en el futuro.	Retirez soigneusement tous les matériaux d'emballage et conservez-les pour un usage ultérieur.
Keep all hardware parts and packaging out of reach of small children.	Conservez toutes les pièces matérielles et les emballages hors de portée des petits enfants.	Mantenga todas las piezas y embalajes de hardware fuera del alcance de los niños pequeños.
Choose a clean, level, spacious assembly area. Avoid hard surfaces that may damage the product.	Choisissez une zone d'assemblage propre, de niveau et spacieuse. Évitez les surfaces dures qui pourraient endommager le produit.	Elija una zona de ensamblaje limpia, nivelada y espaciosa. Evite superficies duras que puedan dañar el producto.
Ensure that you have all required contents for complete assembly.	Assurez-vous que vous avez tous les contenus requis pour l'assemblage complet.	Asegúrese de que tiene todos los contenidos necesarios para el ensamblaje completo.
Take care when lifting. Assemble the product in close proximity to where you intend to position the item.	Prenez soin de soulever. Assemblez le produit à proximité de l'endroit où vous comptez positionner l'élément.	Tenga cuidado al levantar. Ensamble el producto cerca de donde tiene la intención de posicionar el artículo.
Do not over tighten the screws and bolts as this may damage the threads.	Ne serrez pas trop les vis et les boulons car cela pourrait endommager les filets.	No apriete excesivamente los tornillos y pernos, ya que esto puede dañar los hilos.
Do not let children play with this product.	No permita que los niños jueguen con este producto.	Ne laissez pas les enfants jouer avec ce produit.
⚠ Risk of suffocation! Keep any packaging materials away from children.	⚠ ¡Riesgo de sofocación! Mantenga los materiales de embalaje lejos de los niños.	⚠ Risque d'asphyxie! Tenez tous les matériaux d'emballage à l'écart des enfants

Lamp Care Instructions	Instrucciones de lámparas	Entretien de la lampe
Carefully read through the instruction sheet before assembly and using the product.	Lea cuidadosamente la hoja de instrucciones (si fue proporcionada) antes de armar y utilizar la lámpara.	Avant de procéder à l'assemblage et à l'utilisation de la lampe, lisez attentivement le mode d'emploi.
Caution there is a risk of shock. Disconnect from power source before assembling or cleaning.	Peligro por descarga eléctrica. Desconecte la lámpara de la fuente de electricidad antes de armarla o limpiarla.	Pour éviter tout risque d'électrocution, débranchez la lampe de la prise électrique avant de procéder à l'assemblage ou au nettoyage de la lampe.
⚠ WARNING: Wires need to be connected to driver found in canopy and should not be connected directly to power source or a short may occur.	⚠ ADVERTENCIA: los cables deben estar conectados al conductor que se encuentra en el dosel y no deben conectarse directamente a la fuente de alimentación o se puede producir un cortocircuito.	⚠ AVERTISSEMENT: Nécessité de câbles à connecter au pilote trouvé dans la canopée et ne doit pas être connectée directement à la source d'alimentation ou un court-circuit peut se produire.
Only use the recommended bulb type and do not exceed the maximum wattage as it could cause fire.	Solo utilice el tipo de bombilla recomendado y no exceda la potencia eléctrica máxima ya que puede causar un incendio.	Afin d'éviter tout risque de feu, utilisez le type et la puissance d'ampoule recommandés.
Do not plug the product in if cord is torn or frayed.	No conecte la lámpara si el cable eléctrico está dañado o deshilachado.	Ne branchez pas la lampe si son cordon d'alimentation est déchiré ou effiloché

Cleaning & Maintenance	Limpieza y mantenimiento	Nettoyage et maintenance
On polished finishes, often using talc powder reduces the appearance of fingerprints and other smudges.	En acabados pulidos, a menudo usando polvo de talco reduce la aparición de huellas dactilares y otras manchas.	Sur les finitions polies, souvent en utilisant la poudre de talc réduit l'apparence des empreintes digitales et d'autres taches.
For respective shade surfaces, use the appropriate cleansers, i.e. glass cleaner, acrylic polish, and wood polish.	Para las respectivas superficies de sombra, utilice los limpiadores apropiados, es decir, limpiador de vidrio, esmalte acrílico y pulido de madera.	Pour les surfaces d'ombrage respectives, utilisez les nettoyeurs appropriés, c'est-à-dire le nettoyeur pour vitres, le Vernis acrylique et le vernis à bois.
Clean with soft cloth and a mild detergent. DO not use abrasive cleaner.	Utilice un trapo limpio, suave y seco que no raye ni manche la superficie cuando quite el polvo.	Nettoyer avec un chiffon doux et un détergent doux. N'utilisez pas de nettoyeur abrasif.
Periodically (every 90 days) make sure that the screws are fully tightened.	Periódicamente (cada 90 días) asegúrese de que los tornillos estén bien apretados.	Périodiquement (tous les 90 jours), assurez-vous que les vis sont bien serrées.
Prolonged exposure to heat sources may cause glazing, melting and scorching, or even cause color to fade.	La exposición prolongada a las fuentes de calor causa cristalización, derretimiento, quemadura y decoloración del tapizado.	Si le tissu subit une exposition prolongée aux sources de chaleur, il pourrait commencer à reluire, à roussir, à s'estomper ou même à se décolorer.