

WARNING: DISCONNECT POWER AT THE MAIN FUSE BOX BEFORE INSTALLATION.

WARNING:

This fixture is intended for installation in accordance with the National Electrical Code (NEC) and all local code specifications. If you are not familiar with code requirements, installation by a certified electrician is recommended.

Before assembly, remove all parts and part packages from box. If anything is missing, please contact the retailer from which the product was purchased.

elk HOME

ANY QUESTIONS CALL: 800-613-3261
M-F 8:00AM-6:00PM ET

ITEM#: 85341/1

1. Carefully pull house wires out of junction box so they are easily accessible during installation.
2. Position mounting bracket (A) so the head of the attached ground screw is pointing down towards floor.
3. Place mounting bracket (A) up against junction box. Align each slot in mounting bracket (A) with each hole in junction box.
4. Thread one junction box screw (B) into each slot in mounting bracket (A) and into holes in junction box. Tighten junction box screws (B) to secure mounting bracket (A) to junction box.

CAUTION: Make sure house wires are still easily accessible. **DO NOT** pinch wires between mounting bracket and ceiling.

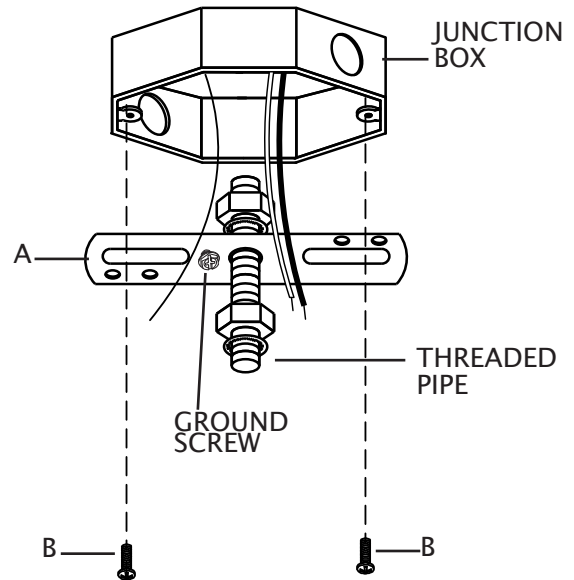

5. If canopy (D) is not already installed on cord (G), hold canopy (D) so outside of canopy (D) is pointing down towards floor. Push fixture wires up through hole in canopy (D). Carefully pull fixture wires up through canopy (D). If the strain relief (F) needs to be moved, loosen set screw on strain relief (F). Move strain relief (F) to desired position.
6. Hold canopy (D) against ceiling to determine desired hanging height of fixture.
7. Carefully pull cord (G) down or push cord (G) up through canopy (D) to achieve desired length. Tighten set screw to secure cord (G).

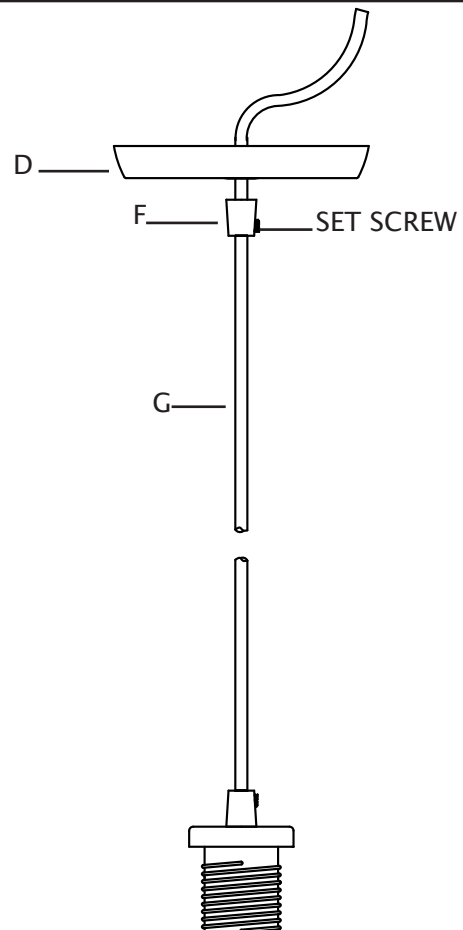

8. Strip 3/4" of insulation from ends of fixture wires.
9. Carefully push fixture wires up through end of threaded pipe on mounting strap (A). Pull fixture wires out of top of threaded pipe.

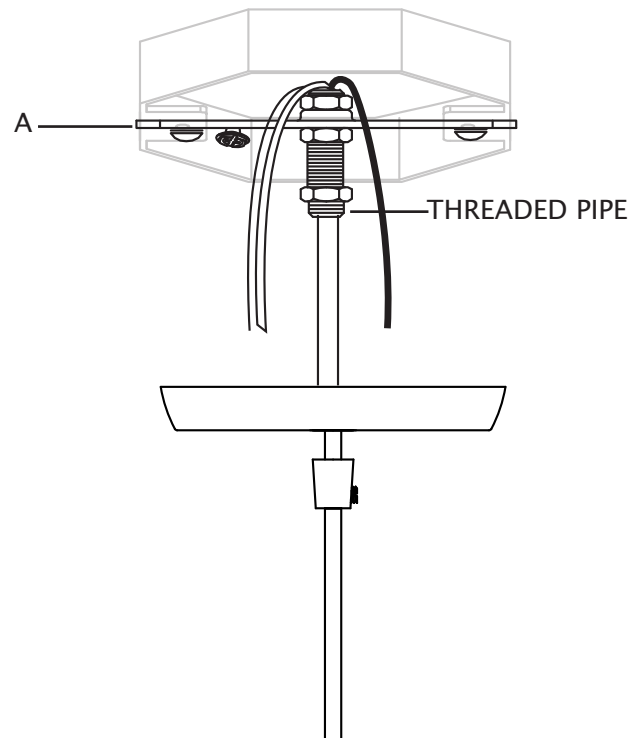

10. Slightly loosen ground screw on mounting bracket (A). Do not completely remove ground screw. Wrap house ground wire (copper) around ground screw, leaving enough ground wire to attach to fixture ground wire. Twist end of fixture ground wire and end of house ground wire (copper) together. Twist wire nut (C) onto ends of wires. Completely tighten wire nut (C). Reference chart below for correct wire connections.

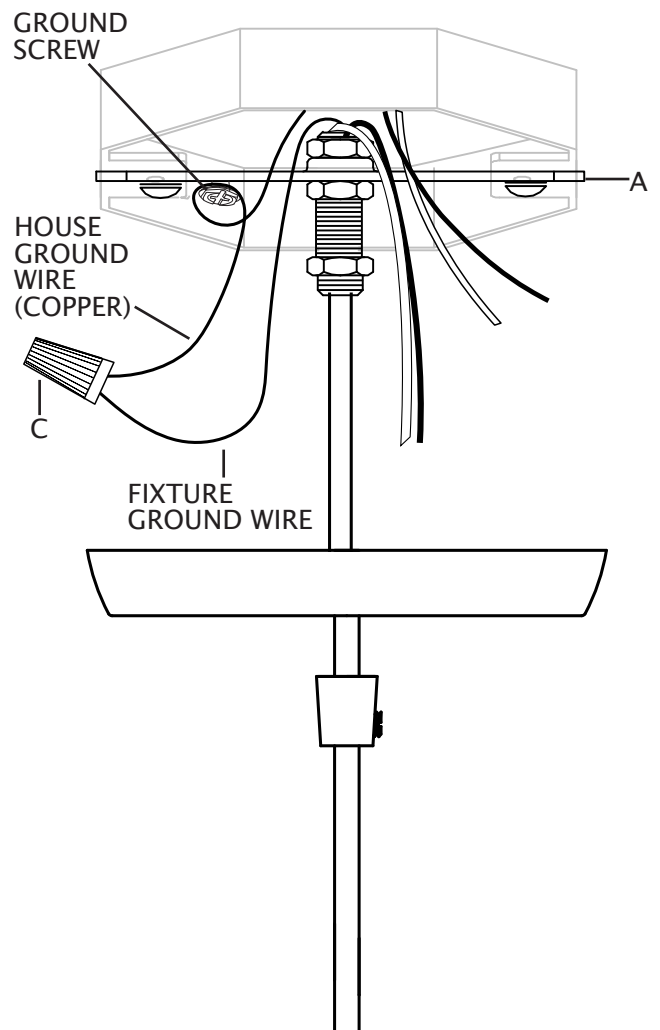

Connect Supply (House) Ground Copper Wire to:

Bare Copper Wire or,

Bare Silver Wire or,

Green Insulated Wire.

11. Twist end of house lead wire (black) and end of fixture lead wire together. Twist wire nut (C) onto ends of wires. Completely tighten wire nut (C). Twist end of house neutral wire (white) and end of fixture neutral wire together. Twist wire nut (C) onto ends of wires. Completely tighten wire nut (C). Reference chart to the right for correct wire connections.
12. Wrap electrical tape (not included) around wire nuts (C) and wires. Ensure wires are securely fastened into wire nuts.
13. Carefully push all wires and wire nuts into junction box.

Connect Black Lead Supply (House) Wire to:	Connect White Neutral Supply (House) Wire to:
Black Wire or,	White Wire or,
*Parallel Cord (Round and Smooth) or,	*Parallel Cord (Square and Ridged) or,
No printed words on wire insulation or,	Printed words on wire insulation or,
Insulated Wire (other than green) with Copper Conductor.	Insulated Wire (other than green) with Silver Conductor.

*When parallel wire (SPT 1 & SPT 2) is used:
The lead wire is round in shape or smooth.
The neutral wire is square in shape or ridged.

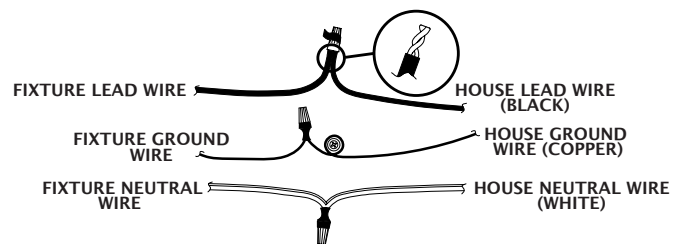

14. Raise canopy (D) up to ceiling. Pass hole in center of canopy (D) over end of threaded pipe on mounting strap (A).
15. Loosen set screw on strain relief (F). Slide strain relief (F) up the cord (G). Thread strain relief (F) onto end of threaded pipe. Tighten strain relief (F) to secure canopy (D) up against ceiling. Tighten set screw on strain relief (F).
16. Raise shade (K) up to fixture. Pass hole in top of shade (K) over socket. Thread socket ring (L) onto socket. Tighten socket ring (L) to secure shade (K) in place.
17. Screw recommended bulb (E26 Edison bulb type, not included) into socket. Verify correct bulb wattage marked on socket of fixture. **WARNING: DO NOT** exceed maximum bulb wattage.

