

# HINTS & TIPS



# Assembly Instruction

# MOE'S

home collection

Moe's Item #OT-1006-30

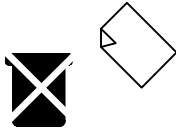

Please retain this assembly instruction for future use.

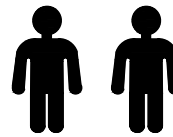
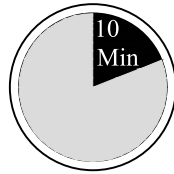

This assembly requires two people

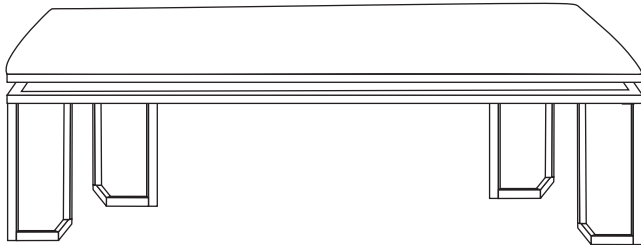

PLEASE READ this sheet prior to assembly to familiarize yourself with the various stage of construction. carefully open the pack supplied and check the contents against the part and fittings check list.

Do not destroy any of the packing until you are certain that you have all the necessary parts for the assembly.

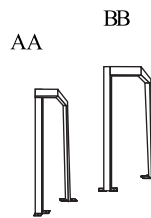

ITEM	Description	Qty
A	Bench Top	01
B	Leg Support Pipe	01
AA	Legs	02
BB	Legs	02

## CARE & MAINTENANCE

To maintain the appearance of your unit, clean regular dusting with a soft cloth will be adequate. For grime stains, wipe with a damp cloth and mild detergent.

Sr. No.	Description	Qty
A	Allen Bolt (16x8)	16
B	Allen-Key	01

## Figure 1

Place Bench Top (A) on soft flat surface & Put Leg Support Pipe (B) on Part (A) and fixing Part 'AA' on Part (B) & Part (AA) with Allen Screw (A).

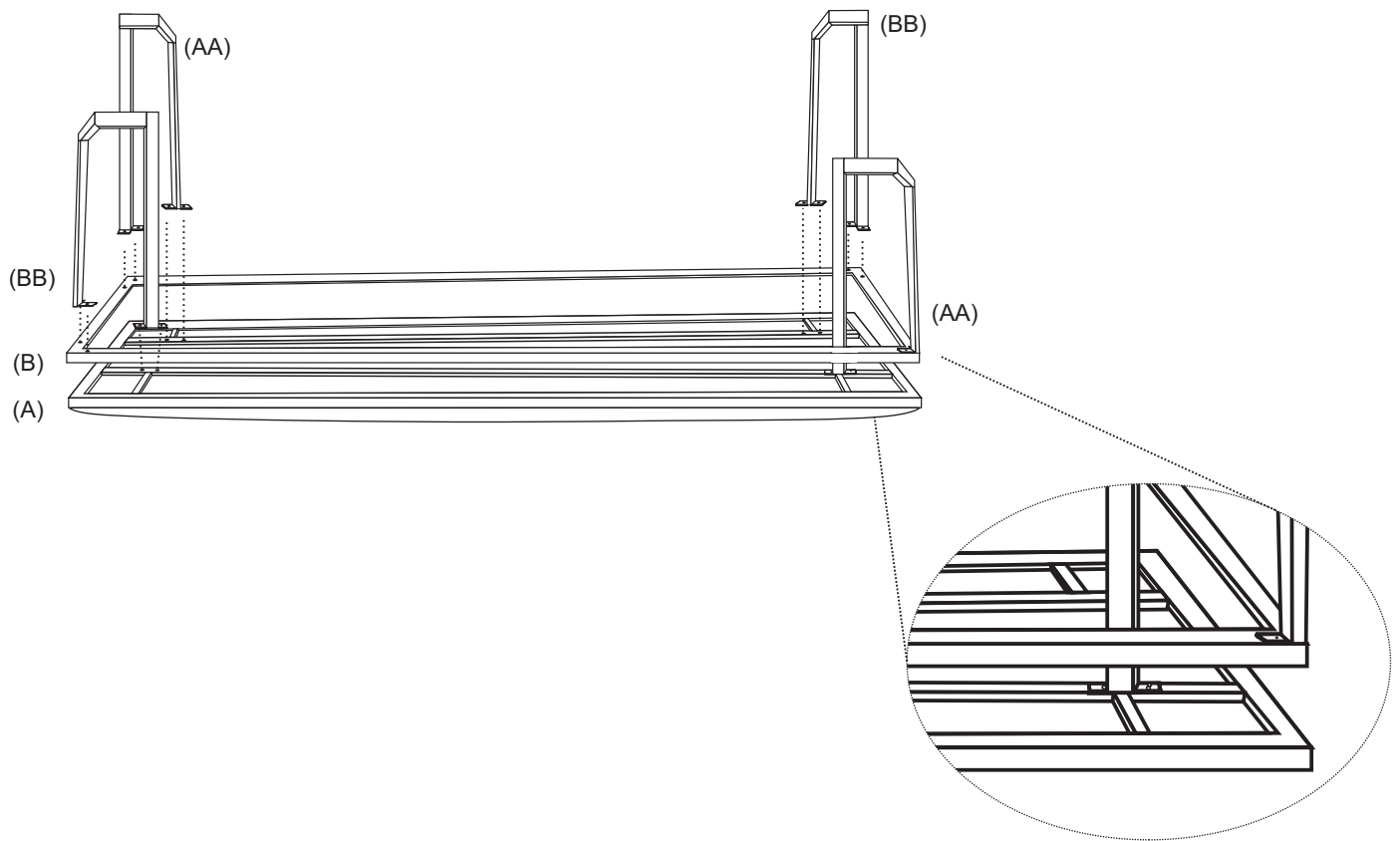

## Figure 2

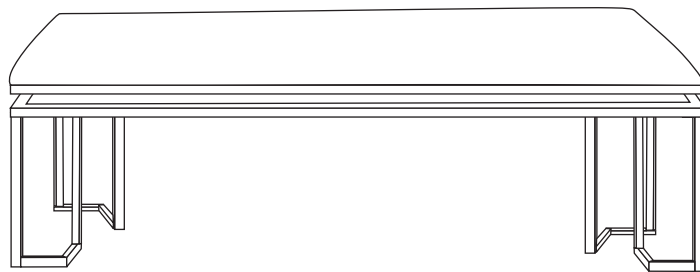

{Assembled Piece}