

MOE'S

h o m e c o l l e c t i o n

ASSEMBLY INSTRUCTIONS.

MADAGASCAR 1 DRAWER NIGHTSTAND

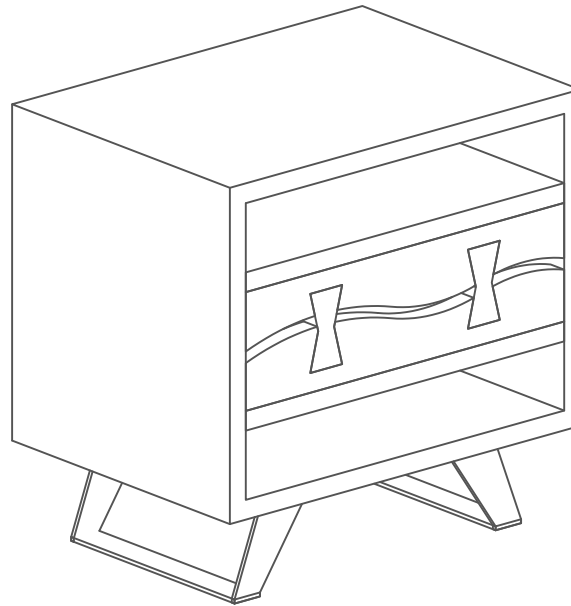

UH-1008-03





THANK YOU FOR YOUR PURCHASE!

PARTS AND HARDWARE.

PART LIST

NO.	DESCRIPTION	IMAGE	QTY
1.	WOODEN BEDSIDE		01
2.	METAL LEGS		02

HARDWARE LIST

NO.	DESCRIPTION	IMAGE	QTY
5.	Allen bolt-M8-25MM		04
6.	Washer		04
7.	Allen key-6MM		01

NOTES.

Thank you for purchasing this quality Product! Be sure to check all packing material carefully for small part that may have come loose inside the carton during shipping.

CAUTION: The item is heavy, assembly should be performed by two people.

STEP 1.

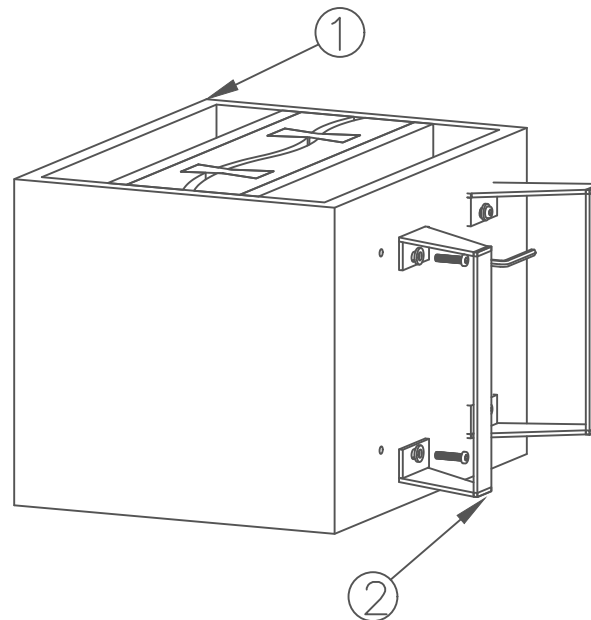

STEP 2.

