

Tools Required

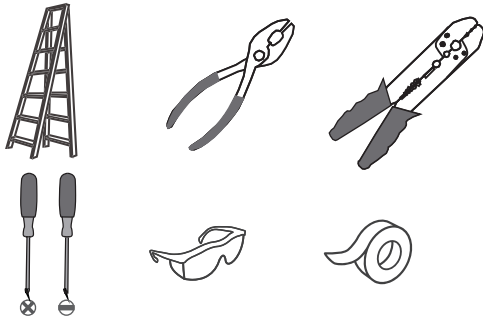

Light Source

17W
LED

Warnings and Cautions

Turn off the electricity at the circuit breaker before installation. Consult a licensed electrician if in doubt about installation.

Package Contents

Preparation: Identify and inspect all parts before beginning the installation.

Missing or damaged parts? Contact your original place of purchase.

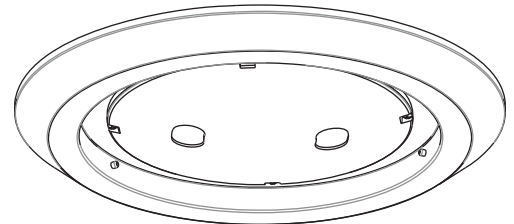

E Fixture Body
x 1

PARTS BAG

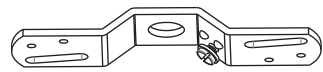

A Crossbar
x 1



C Outlet Box Screw
x 2



B Mounting Screw
x 2



D Wire Connector
x 3

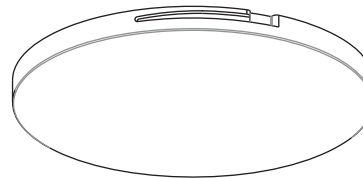

F Shade
x 1

Table of Contents

Inner Backplate

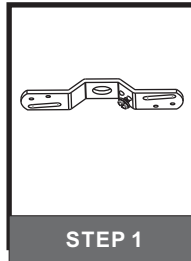

Wiring

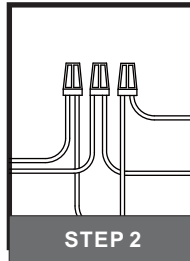

Fixture Body

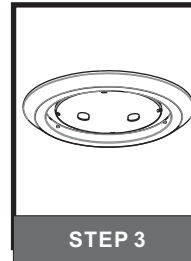

Shade

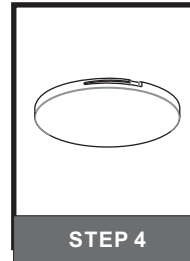

STEP 1

1

Determine mounting holes for mounting screws

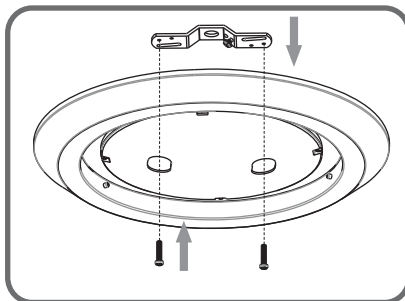

2

Install mounting screws

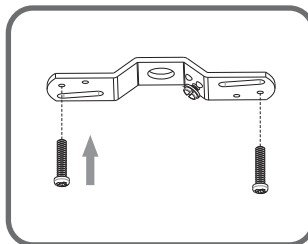

3

Install Crossbar

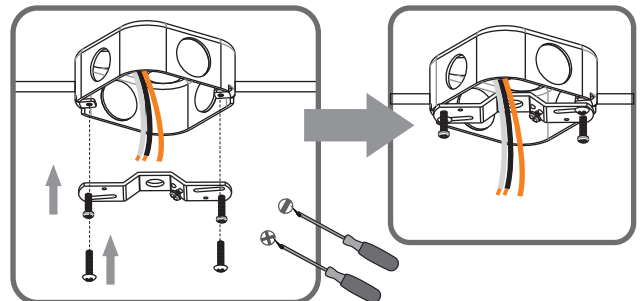

STEP 2

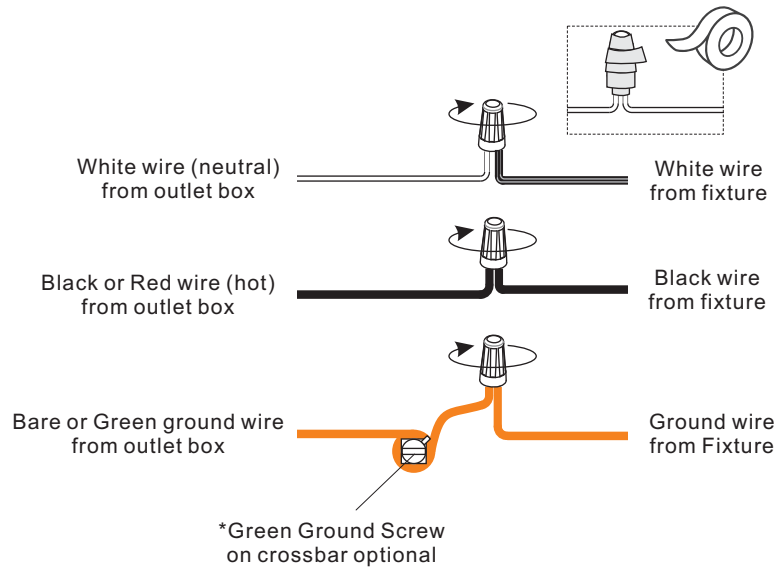

STEP 3

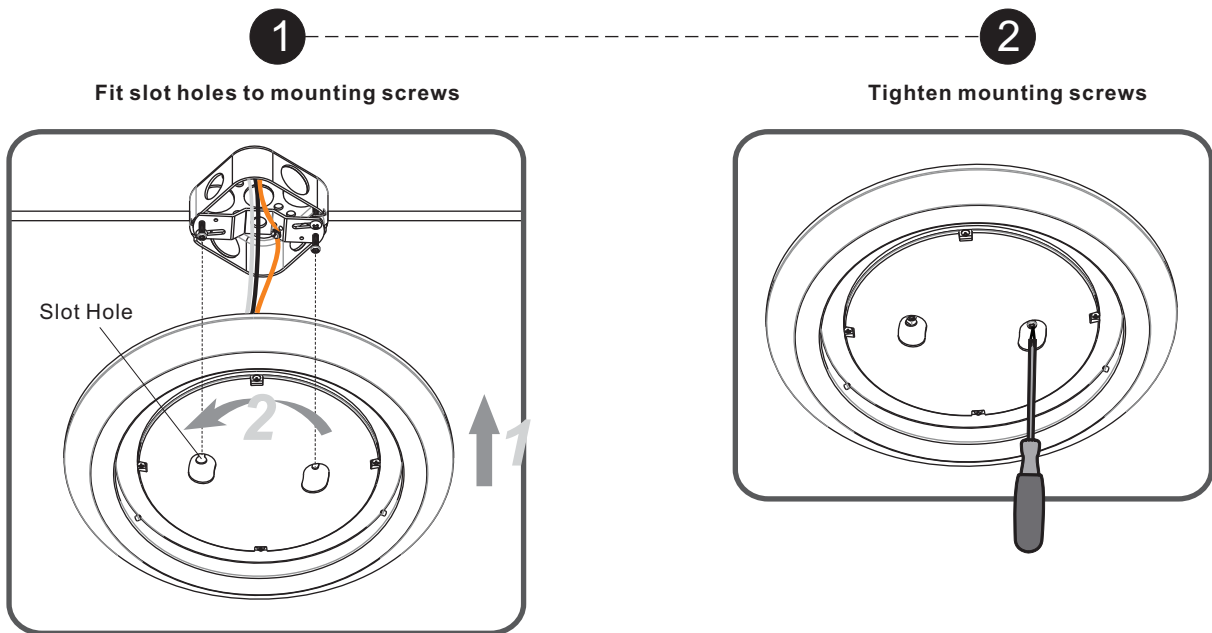

STEP 4

