

**CEILING FAN INSTALLATION
AND OPERATION MANUAL
(MODEL NUMBER:AC-30760)**

READ AND SAVE THESE INSTRUCTIONS

SAFETY PRECAUTIONS

WARNING-INSTALLATION SHOULD BE PERFORMED BY A QUALIFIED ELECTRICIAN

1. To ensure the success of the installation, be sure to read the instructions and review the diagrams thoroughly before beginning.
2. All electrical connections must be in accordance with local codes, ordinances or National Electrical Code. If you are unfamiliar with methods of installing electrical wiring secure the services of a qualified electrician.
3. Make sure that your installation will not allow rotating fan blades to come in contact with any object.
4. If you are installing more than one ceiling fan, make sure that you do not mix fan blade sets.
5. Only mount fan to outlet box marked acceptable for ceiling fan.
6. Installation to a concrete ceiling should be performed by a qualified electrician.
7. Before beginning, disconnect power by removing fuse or turning off circuit breaker.
8. After fan is completely installed, make sure that all connections are secured to prevent fan from falling.
9. Do no insert anything into the fan blades while ceiling fan is operating.
10. The fan must be mounted with the blades at least 2.1m from the floor to minimum the possibility of accidental contact with the fan blades.
11. The supply wires Live & Neutral must be connected to wall switch (double poles) having a contact separation at least 3mm in all poles.

NOTE : The important safeguards and instructions appearing in the manual are not meant to cover all possible conditions and situations that may occur. It must be understood that common sense. Caution and carefulness are factors which cannot be built into any product. These factors must be supplied by the person(s) caring for and operating the unit.

WARNING

To reduce the risk of personal injury, do not bend the blades when installing the blades, balancing the blades or cleaning the fan. Do not insert foreign objects between rotating fan blades.

WARNING

The box must be supported directly by the building structure. The box and its support must be able support the fan weight - must not twist or work loose. Do not use plastic boxes.

Installing Blade Assembly

1. Attached each blade assembly to the housing using the blade screws . Tighten them securely.(See fig.1)

Caution: To reduce the risk of personal injury. Do not bend the blade when installing, balancing or cleaning the fan. Do not insert foreign objects between rotating fan blades.

Putting Your Fan Together

1. Remove the hairpin clip & washer from the clevis pin and remove clevis pin from down rod. (See fig.2)
2. Insert the down rod through the center opening in the canopy,coupling cover and route the motor leads through the hanger ball/downrod assembly. Align the clevis pin holes in the downrod with the holes in the motor coupling. The clevis pin must pass through the holes in the motor coupling and the downrod. Place the washer onto the clevis pin and install the hairpin clip making sure to push straight leg of the hairpin clip through the hole near hanger ball to make sure the clevis pin is properly installed(See fig.3)
3. Reinstall the 2 set screws in the motor coupling and securely tighten set screws against the down rod assembly.(See fig.4 & 5)

Hanging Your Ceiling Fan

1. Securely attach the hanger bracket to the outlet box by washers and screws supplied. Connect white wire from ceiling to white wire from receiver with wire nut. Connect black wire from ceiling to black wire from receiver with wire nut. (See fig.6)
2. Carefully lift the fan and seat the down rod ball assembly on the hanger bracket. Be sure the groove in the ball is lined up with tab on the hanger bracket .Do not pinch wires between the ball and down rod assembly and hanger bracket .(See fig.7)
3. Install the safety cable into the building structure. (See fig.8)

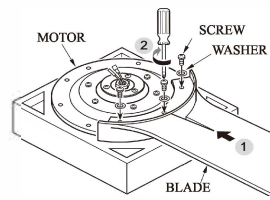

FIG.1

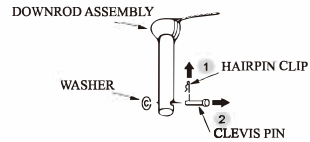

FIG.2

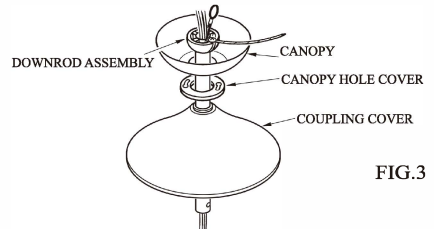

FIG.3

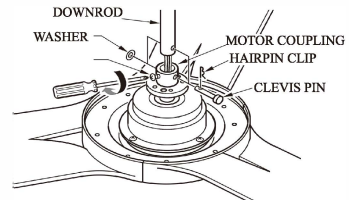

FIG.4

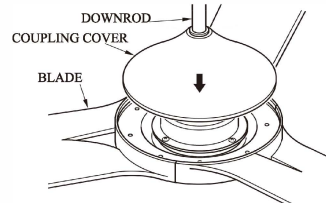

FIG.5

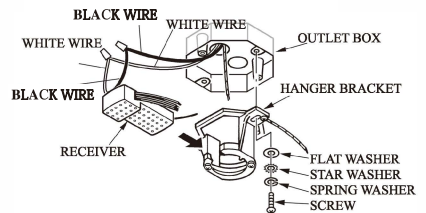

FIG.6

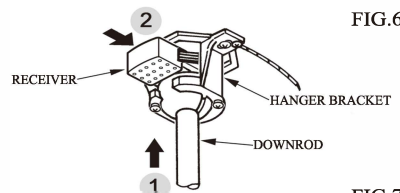
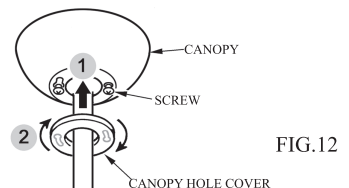
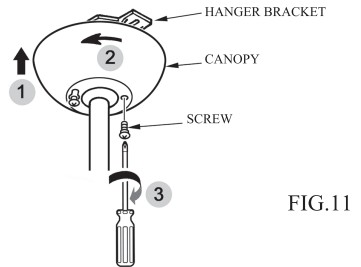
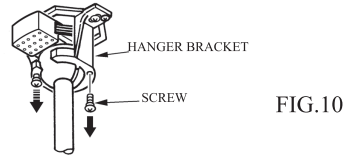
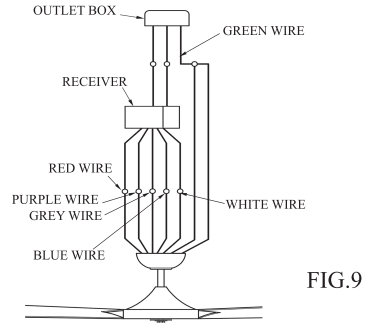
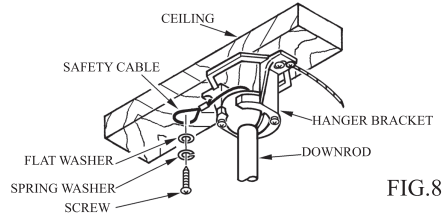

FIG.7

Wiring Your Ceiling Fan

Caution: To avoid possible electrical shock, be sure electricity is turned off at the main fuse box before wiring.

1. If you are not sure that the electrical box is grounded, contact a licensed electrician for advice. It must be grounded for safe operation.
2. Connect the red wire from receiver to the red wire from fan with wire nut. Connect the purple wire from receiver to the purple wire from fan with wire nut. Connect the blue wire from receiver to the blue wire from fan with wire nut. Connect the grey wire from receiver to the grey wire from fan with wire nut. Connect the white wire from receiver to the white wire from fan with wire nut. Connect the green or bare copper wire from outlet box to the green wires from receiver, hanger bracket and down rod ball with wire nut. (See fig.9)
3. Remove one of screws and loosen the other screw from the hanger bracket. (See fig.10)
4. Mount the canopy on the hanger bracket and tighten the screws. (See fig.11)
5. Place the canopy hole cover over the screws and twist the cover to tighten. (See fig.12)



Installing The Light Kit

1. Remove 1 of 3 screws on light kit adapter, and loosen the other 2 screws. (see Fig.13)
2. Gently pull the wire through light kit plate. Align the three holes on light kit plate with light kit adapter. Then, tighten back the screws removed previously.(See fig.14 & 15)
3. Remove the 3 screws from the light kit and keep it for future use.(See fig.16)
4. Plug together light kit wires from fan to light kit wires from LED light.(See fig.17)
5. Screw back the 3 previously removed screws and tighten the light kit.(See fig.18)
6. Attach the PC shade by locating tabs in light kit with grooves on the light shade and twist clockwise until tight (See fig.19)

Installing The Bottom Cap

If light not required, you can use the bottom cap instead of LED light module and shade. Light kit plate will still need to be installed to fan but do not attach the LED light module to the light kit plate.

Line up slot in bottom cap with tab on light kit plate and turn clockwise until it locks in place and is firm.(See Fig.20)

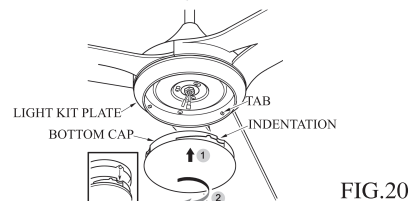
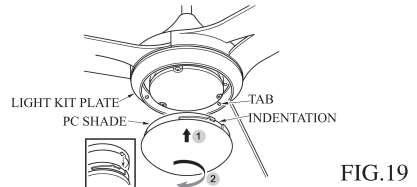
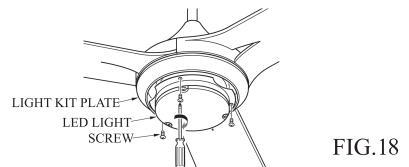
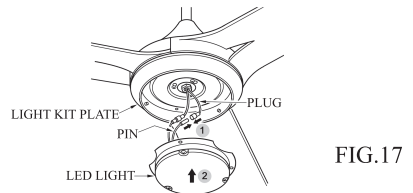
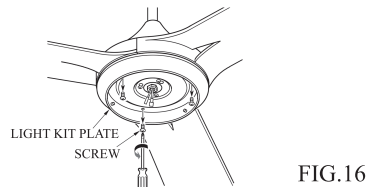
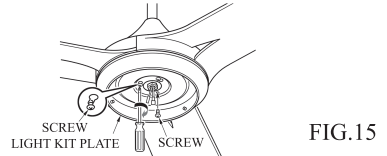
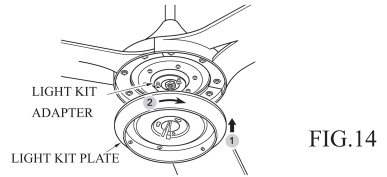
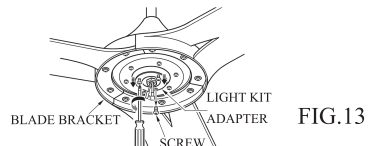

Operation in Summer

In warm weather, the reverse switch should be set to produce a downward flow of air. The constant, gentle breeze will transfer heat from your body; thus, you will feel cooler even if the temperature remains unchanged. This cooling effect is referred to as a wind-chill factor. In an air-conditioned home, the wind-chill factor will allow you to set the thermostat higher than the usual setting. While using less energy to air-condition your home, you will stay just as cool.

For summer cooling, set the speed control on medium or fast speed. This will provide sufficient airflow to accomplish a cooling effect. The exception to this is in bedrooms where a brisk, downward flow would be too chilly. A low-speed, gentle breeze is all that is necessary to keep you comfortable at night.

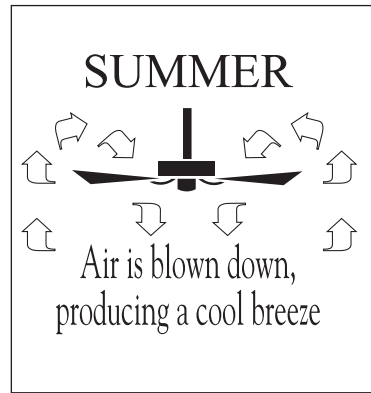

Operating in Winter

Winter comfort requires a different approach. Because warm air rises the air close to the ceiling is always warmer-by perhaps 15 degrees-than the air close to the floor. To prevent heat from hovering where it does little good, move the reverse switch to create an upward airflow. This will pull cool air up and force warm air across the ceiling and down the walls. Set the speed control fast enough to break up the air stratification, but slow enough not to create a draft. By keeping the heat circulating, the heater will not have to operate as often to keep you warm.

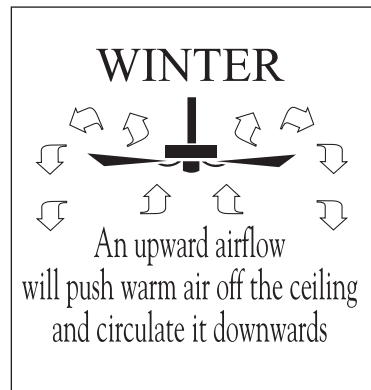

CARE OF YOUR FAN

Here are some suggestions to help you maintain your fan.

1. Because of the fan's natural movement, some connections may become loose. Check the support connections, brackets, and blade attachments twice a year. Make sure they are secure. (It is not necessary to remove fan from ceiling.)
2. Clean your fan periodically to help maintain its new appearance over the years. Use only a soft brush or lint-free cloth to avoid scratching the finish. The plating is sealed with a lacquer to minimize discoloration or tarnishing. Do not use water when cleaning. This could damage the motor, or the wood, or possibly cause an electrical shock.
3. There is no need to oil your fan. The motor has permanently lubricated sealed ball bearings.

TROUBLESHOOTING

Problem	Solution
Fan will not start.	<ol style="list-style-type: none">1. Check main and branch circuit fuses or breakers.2. Check line wire connections to the fan and switch wire connections in the switch housing.3. Check to make sure the dip switches from the transmitter and receiver are set to the same frequency.
Fan sounds noisy.	<ol style="list-style-type: none">1. Make sure all motor housing screws are snug.2. Make sure the screws that attach the fan blade bracket to the motor hub are tight.3. Make sure wire nut connections are not rattling against each other or the interior wall of the switch housing.4. Allow a 24-hour "breaking-in" period. Most noises associated with a new fan disappear during this time.5. If using ceiling fan light kit, make sure the screws securing the glassware are tight. Check that the light bulb is also secure.6. Make sure there is a short distance from the ceiling to the canopy. It should not touch the ceiling.7. Make sure your ceiling box is secure and rubber isolator pads are used between mounting bracket and outlet box.
Remote control malfunction.	<ol style="list-style-type: none">1. Do not connect the fan with a wall mounted variable speed control(s).2. Make sure the dip switches are set correctly.
Fan wobble.	<ol style="list-style-type: none">1. Check that all blade and blade arm screws are secure.2. Most fan wobbling problems are caused when blade levels are unequal. Check this level by selecting a point on the ceiling above the tip of one of the blades. Measure this distance. Rotate the fan until the next blade is positioned for measurement. Repeat for each blade. The distance deviation should be equal within 1/8".3. Use the enclosed Blade Balancing Kit if the blade wobble is still noticeable.4. If the blade wobble is still noticeable, interchanging two adjacent (side by side) blades can redistribute the weight and possibly result in smoother operation.

WARNING: TO REDUCE THE RISK OF PERSONAL INJURY, DO NOT BEND THE BLADE ARM WHILE INSTALLING, BALANCING THE BLADES, OR CLEANING THE FAN. DO NOT INSERT FOREIGN OBJECTS BETWEEN ROTATING FAN BLADES.

REMOTE CONTROL SETTING AND OPERATION

TRANSMITTER OPERATION

Remove the battery cover from the remote control transmitter and install batteries, Replace the cover.

Note : Use 2 1.5V/AAA batteries (included).

Note : If not using for long period of time, remove battery to prevent damage to remote transmitter, and store the remote transmitter away from excess heat or humidity.

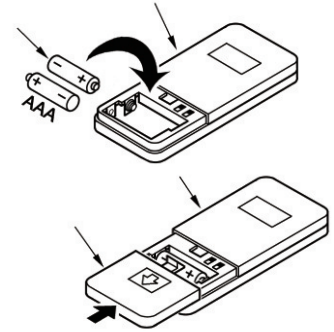

DIMMING / NON DIMMING SETTING

The “DIM” selection is the light dimmable selection , the light will cycle from bright to dim to bright until button is released. The “ON” selection is the light ON/OFF only (non dimming function). Light will maintain last setting if turned off.

Note: The remote control is pre-set with dimming function at factory,

Note: Ensure electricity is turned off before installing the receiver (Refer to the ceiling fan instructions)

The receiver and transmitter are pre-set at the factory so your fan and remote are ready to operate once batteries are installed. Not necessary to go through the Learning Mode process.

1. If controlling two fans by a single remote transmitter, you will need to use the Learning Mode setting (L. CODE).

Power to both fans will have to be restored at the same time and press the Learn button on the remote control so that both fans can receive the signal simultaneously.

2.If the transmitter is learned at common code, any other transmitter at common code can be used directly and no need to be learned again.

Note: Learn Mode setting: Within 60 second of restoring power source to your fan, press and hold the “LEARN” button for at least 3 seconds. If the fan is installed with light, the light wills blink 3 times. This will indicate the process is complete and your fan is ready for use For fans without light, check operation using remote transmitter.

Note: Power must be off for a minimum of 10 seconds, before restoring power to attempt the learn Mode setting procedure.

RECEIVER PROTECTIVE FUNCTIONS

Lock protection- The DC motor has a built-in safety feature against blade or motor obstruction during operation. should something obstruct the fan blades or motor, the motor will keep trying to run for 5 times and then stop operation after about 60 seconds of interruption. Please remove obstacles and reset. To reset, turn the fan off with remote transmitter and then turn the fan on. Or, you may turn the power off for 15 seconds. Then turn the power back on, and then turn the fan on.

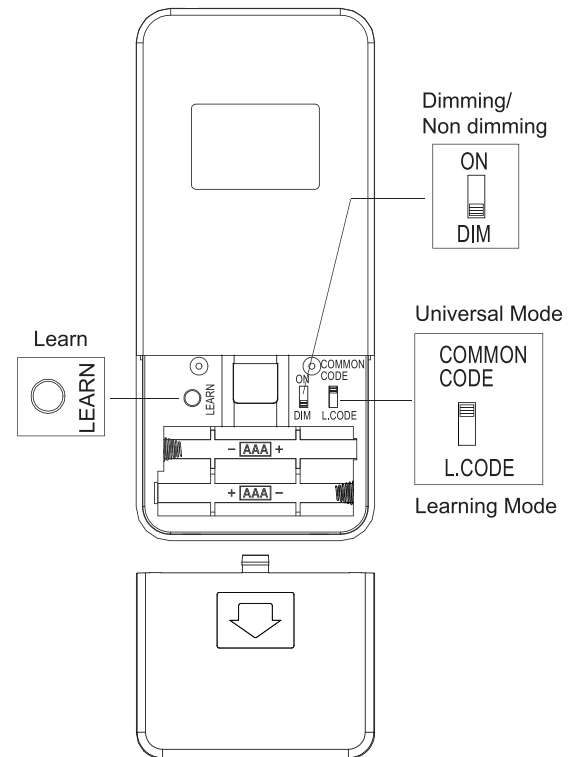

Over load protection (current limit)- The device limits the maximum current output from the receiver/drive when the fan or light load is increased abnormally. The fan will shut off if over lamped.



Remote Control Fan Speed And Light Functions.

Fan speed

- | | |
|-----------------------|------------------|
| 1 = minimum speed | 2 = low speed |
| 3 = medium low speed | 4 = medium speed |
| 5 = medium high speed | 6 = high speed |

-  This button turns the fan off.
-  Forward/Reverse button- This button controls the direction of the fan rotation. Press once to change direction of the fan rotation. Fan must be running to reverse.
-  Light button-Press this button to turn light on or off. To dim light (Setting at "DIM" position), hold down the button, the light will cycle from bright to dim to bright until button is released.

Note: This remote control has an auto resume function, the fan and light will maintain the last setting if power is turned off.

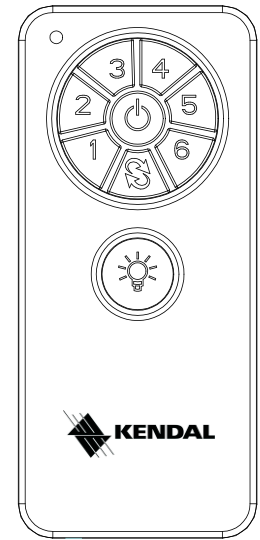

WALL MOUNT CRADLE INSTALLATION

Install Transmitter wall mount cradle with 2 screws provided.

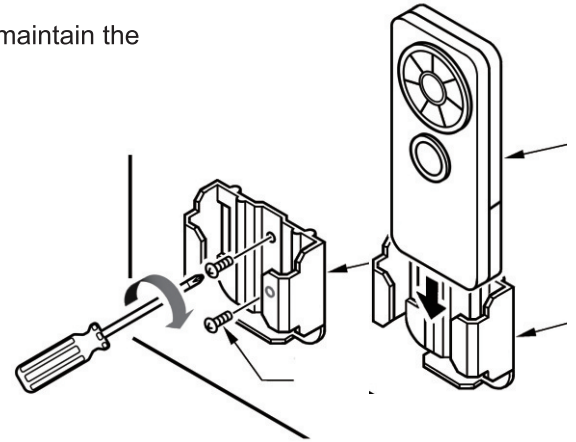

THIS DEVICE COMPLIES WITH PART 15 OF THE FCC RULES OPERATION IS SUBJECT TO THE FOLLOWING TWO CONDITIONS. (1)THIS DEVICE MAY NOT CAUSE HARMFUL INTERFERENCE AND (2) THIS DEVICE MUST ACCEPT ANY INTERFERENCE RECEIVED, INCLUDING INTERFERENCE THAT MAY CAUSE UNDESIRE OPERATION.

NOTE:

1. When powering on after installation, the fan may start automatically due to factory preset settings.
2. If fan or light isn't working, reset power (turn the power off for at least 10 seconds and then turn the power back on) and redo the learn function setting.
3. If there are multiple fans in the same room, when setting, please make sure the power supply for the setting fan is independant of the other fans.
4. When turning the fan on or operating the forward/reverse function, it is normal for the fan to rotate and run on both directions, for approximately 1 minute and then stop.
5. The controller is capable to recording 2 frequency setting, to avoid any frequency issues please ensure both frequencies have been set.