

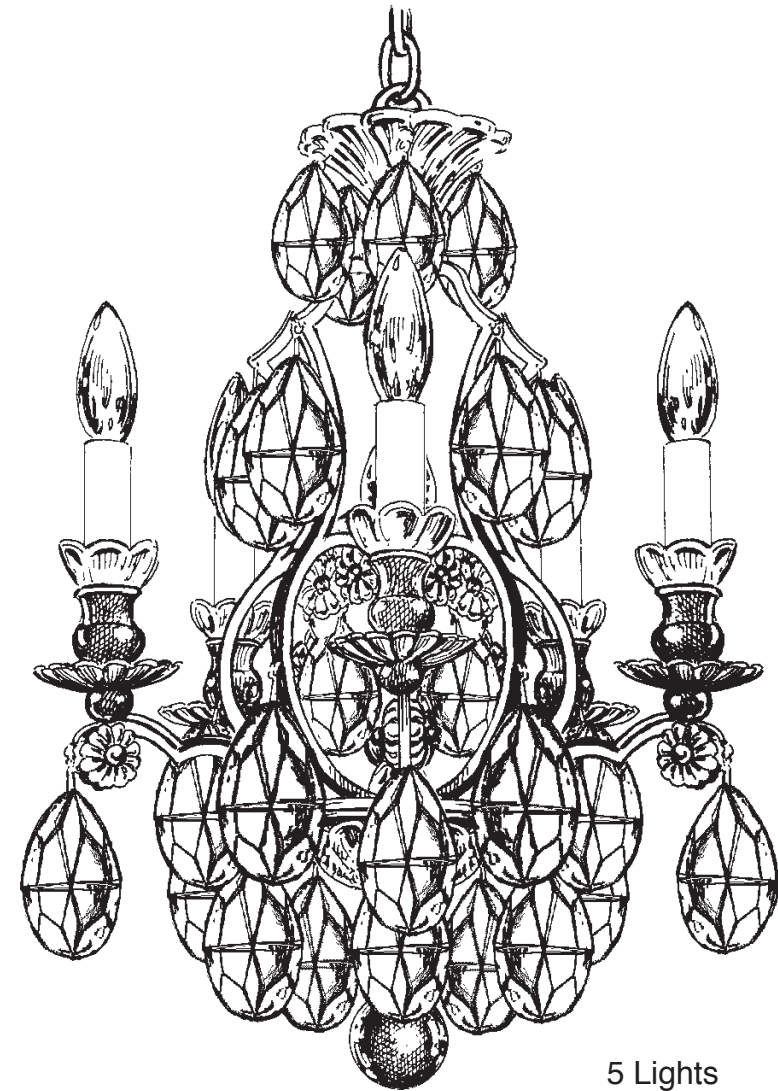

**SCHONBEK®**

**RENAISSANCE 3769- \_\_ \_\_ TK**



**T**HIS DESIGN IS THE PROPRIETARY TRADE DRESS/TRADemark OF SWAROVSKI LIGHTING, LTD.

5 Lights  
Diameter: 14-1/2"  
Body Length: 19"  
Hanging Weight: 10 lbs.



**SCHONBEK®**

MAX <u>60</u> W		110-120 V						

SCHONBEK® is a member of the Swarovski group.

All electrical components must be installed by a licensed electrician in accordance with the National Electric Code and the appropriate local electrical codes.

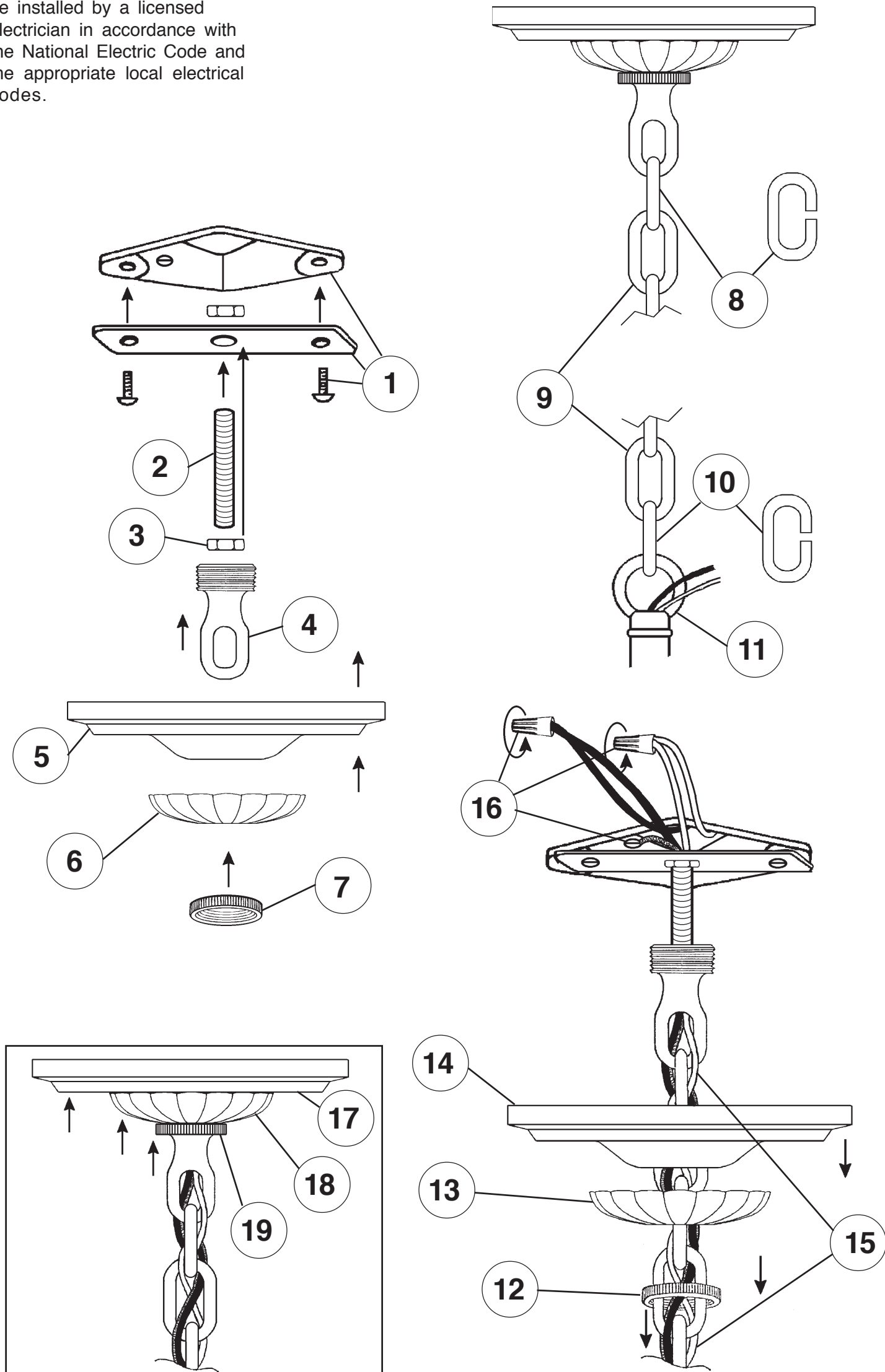

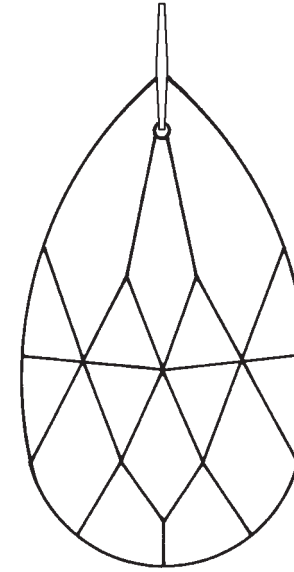
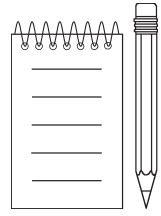

**N4014TK**  
2-1/2"  
63mm

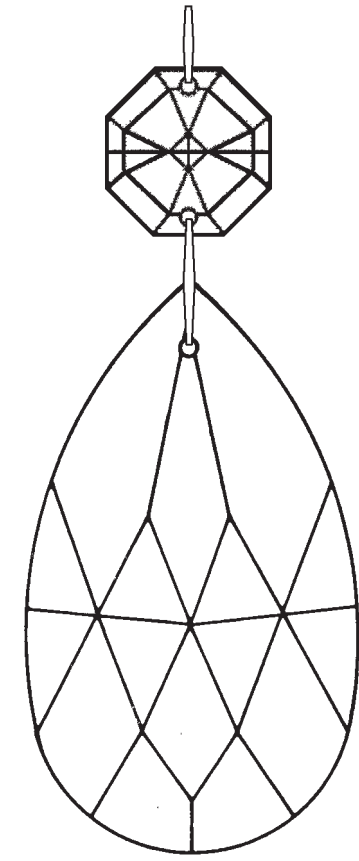

**N4000TK**  
3"  
76mm

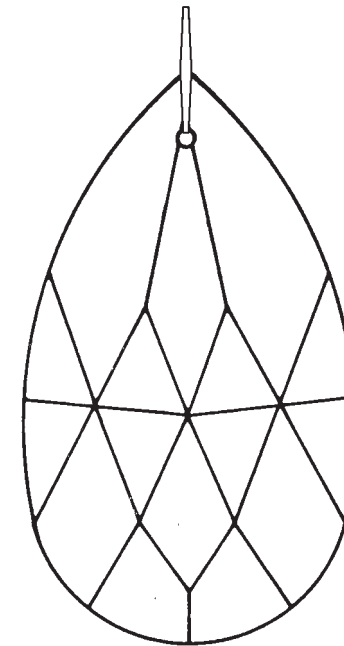

**N4004TK**  
3"  
76mm

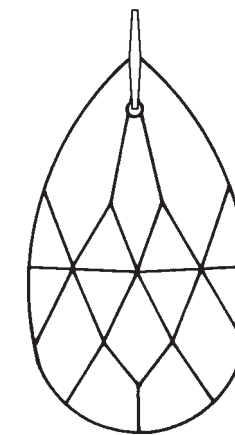

**N4043TK**  
2"  
50mm

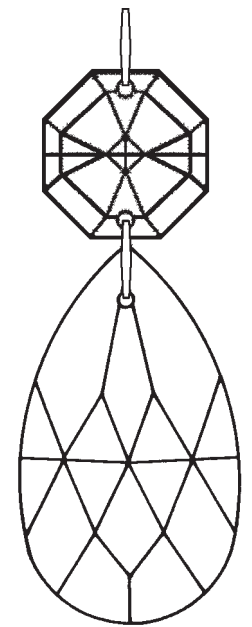

**N4044TK**  
2"  
50mm

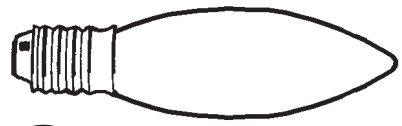

**21** 5 - B10  
60 Watts Max  
25 Watts Recommend

