

# MONORAIL

## MonoRail End Caps

### DESCRIPTION

Decorative end caps fit into ends of MonoRail run for a finished look. Pair; order one pair for each end.

### WEIGHT

0.01lb / 0kg ±

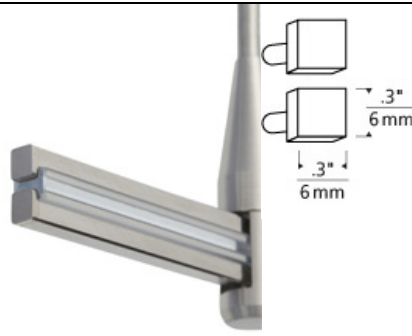

### ORDERING INFORMATION

#### 700MOCCAP FINISH

- Z ANTIQUE BRONZE
- C CHROME
- S SATIN NICKEL



**TECH LIGHTING®**

7400 Linder Avenue  
Skokie, Illinois 60077

T 847.410.4400  
F 847.410.4500

**Tech Lighting, L.L.C.**

700MOCCAP \_\_\_\_

FIXTURE TYPE: \_\_\_\_\_

JOB NAME: \_\_\_\_\_

NOTES: \_\_\_\_\_

\_\_\_\_\_

\_\_\_\_\_



©2014 Tech Lighting, L.L.C. All Rights Reserved. The "Tech Lighting" graphic is a registered trademark of Tech Lighting, L.L.C. Tech Lighting reserves the right to change specifications for product improvements without notification.